

2024-2025 Quality Education Fund Thematic Network - Tertiary Institutes
Progressive Development of STEAM Literacy through STEAM
Education and Self-directed Learning
透過STEAM教育自主學習有序發展STEAM素養

AI tools for teaching or student self-learning

曾梅千禧學校

3D全息投影儀

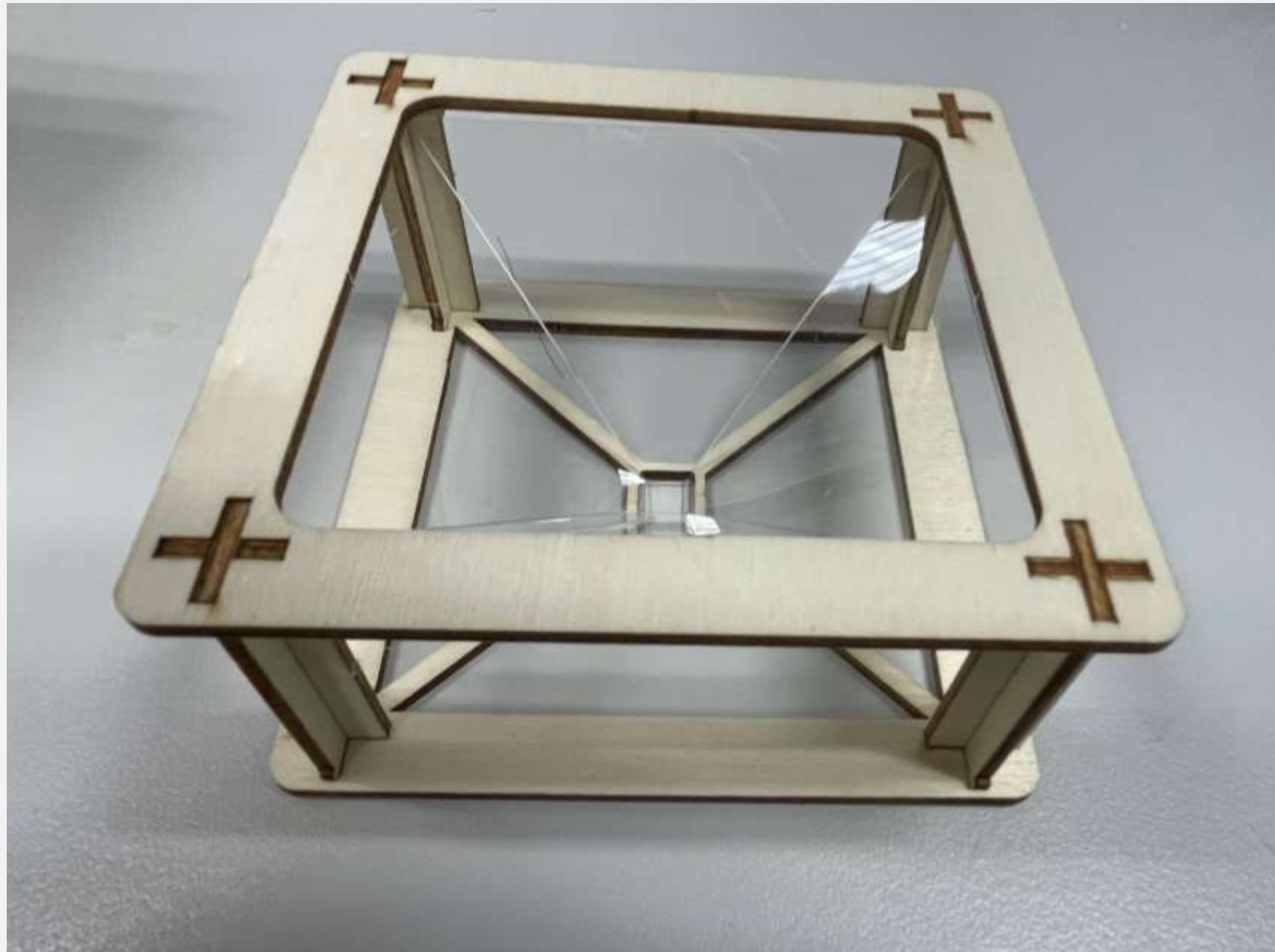

(IPAD和手機都適用)



(分IPAD和手機版本)

DIY 圖紙

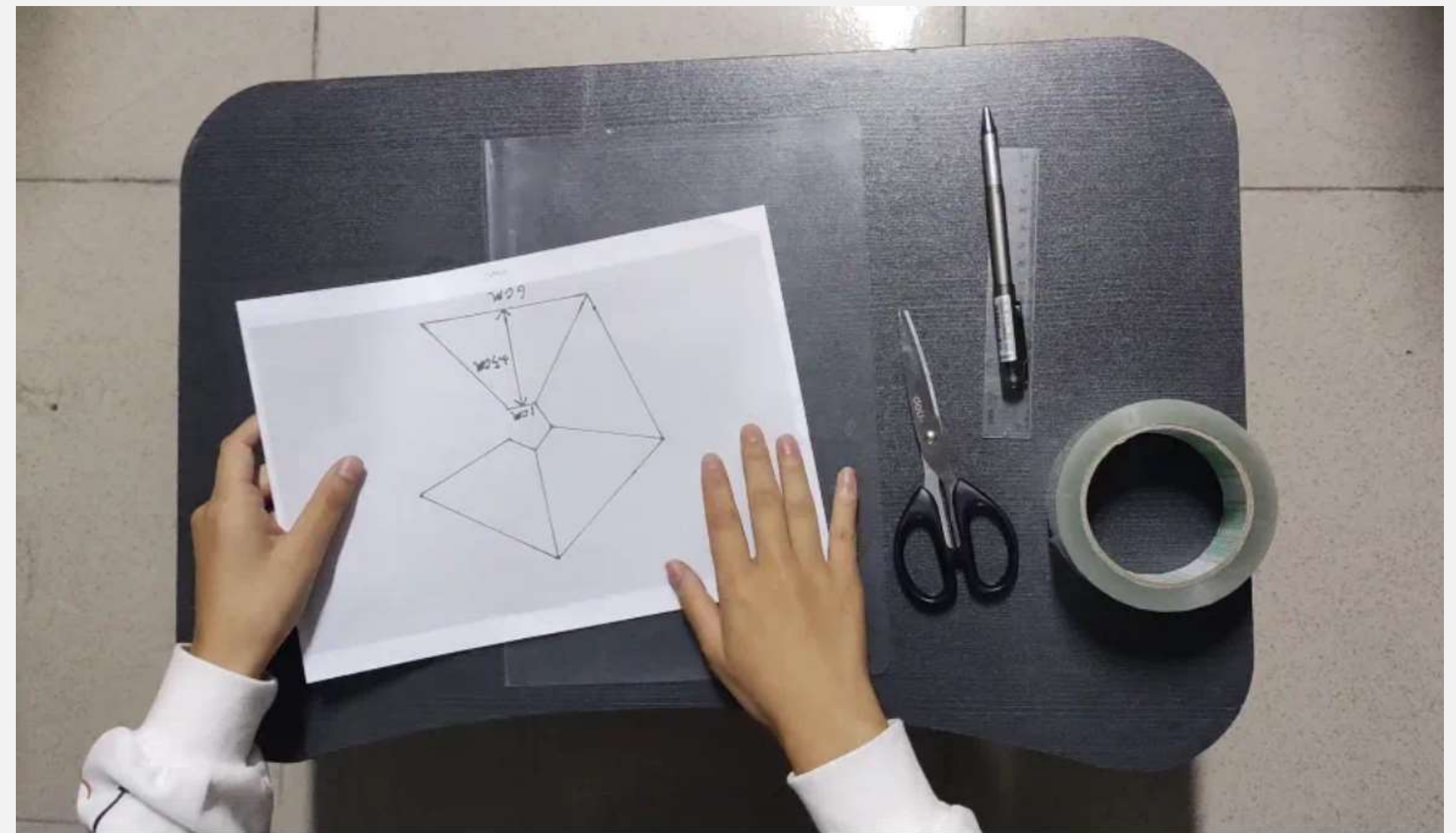
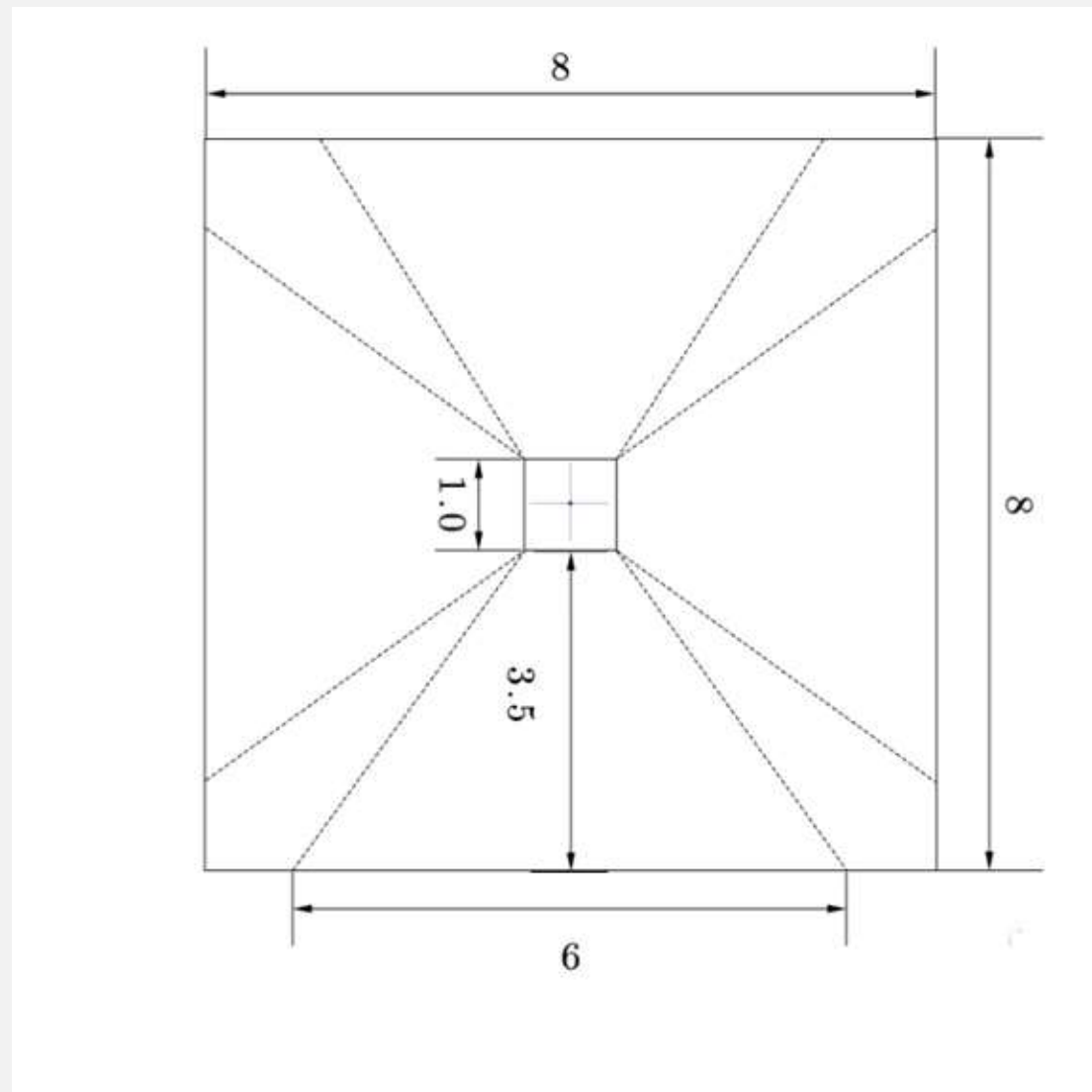

原理（反射、折射）

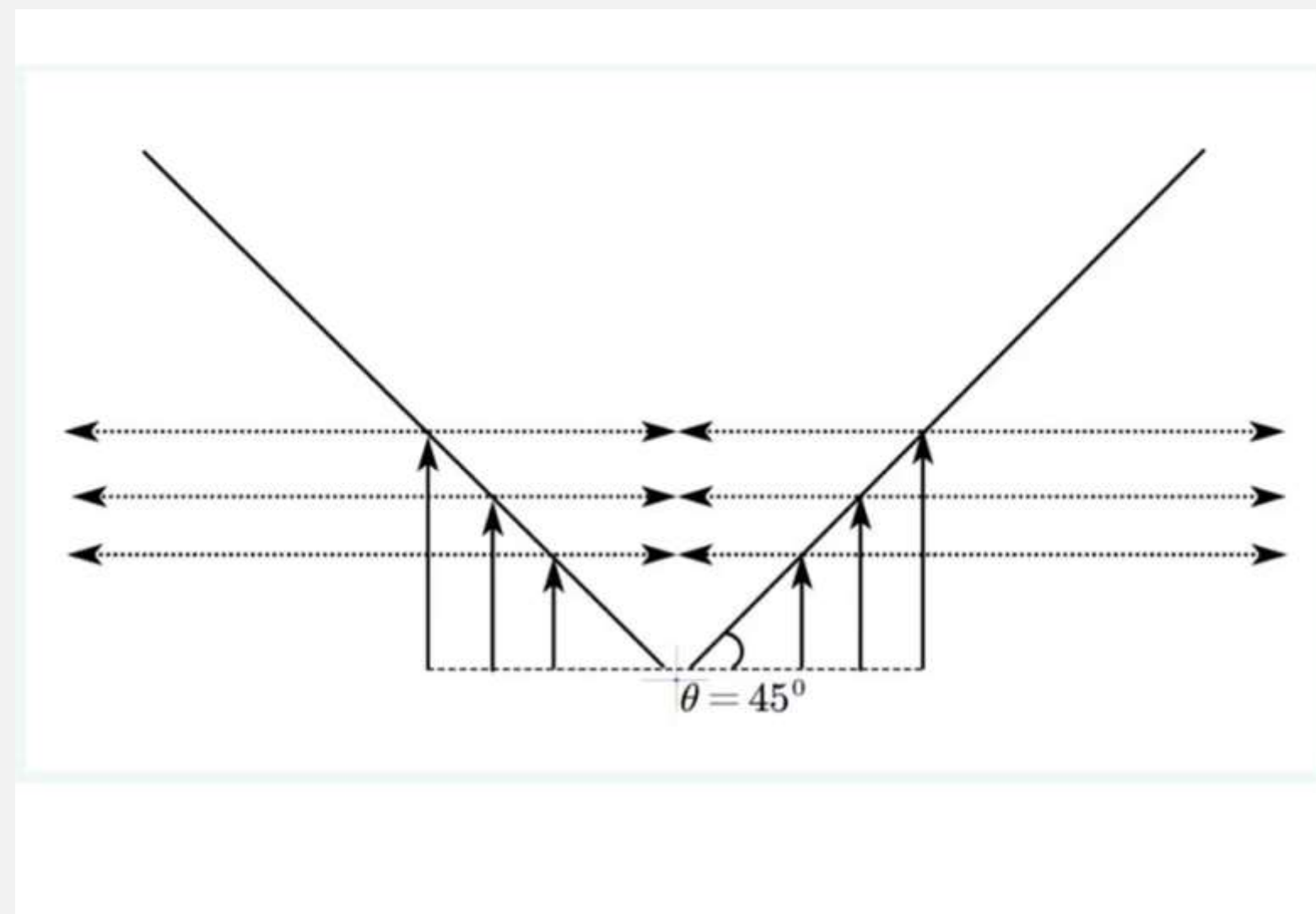

原理（反射、折射）

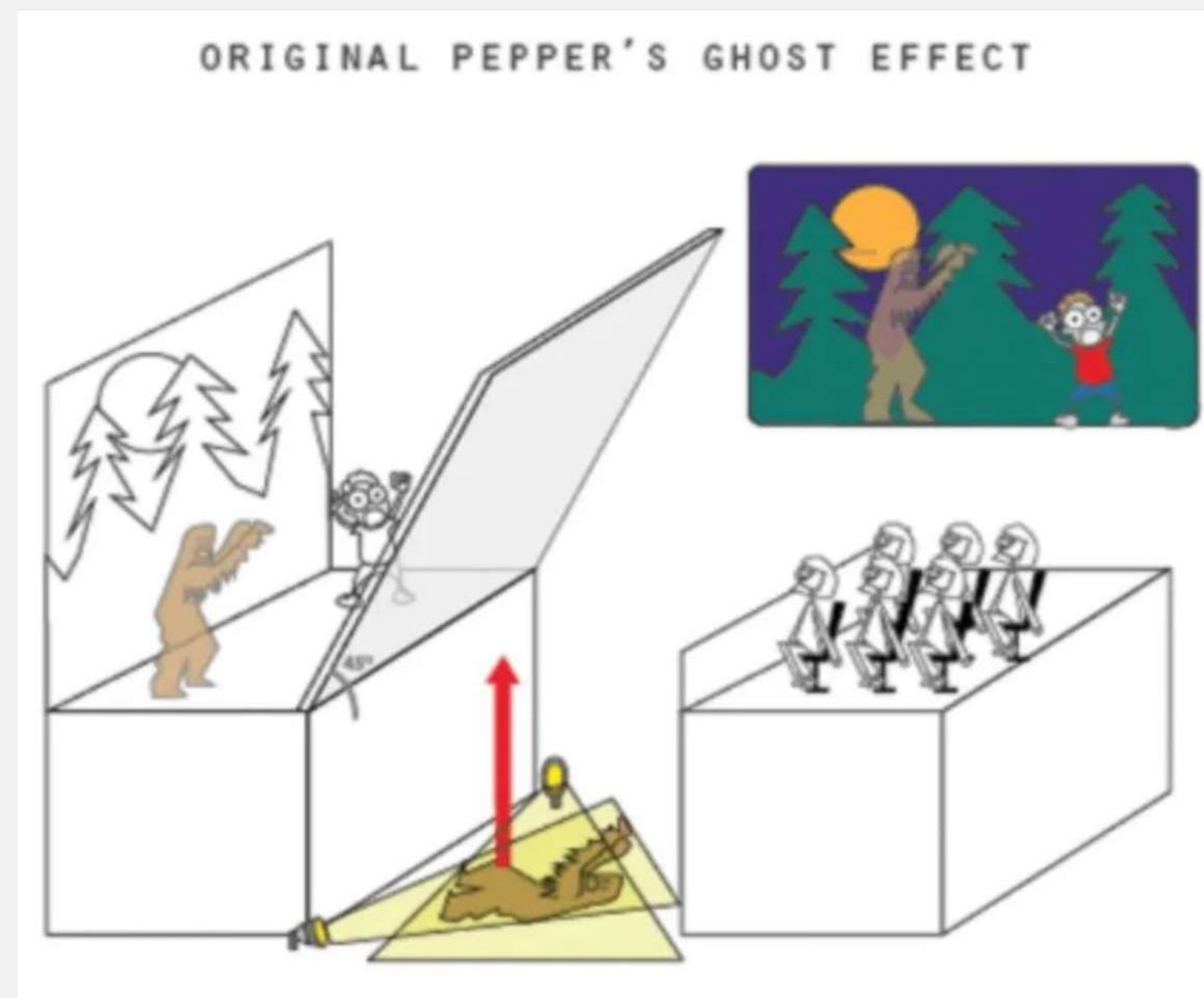

（分IPAD和手機版本）

3D投影效果

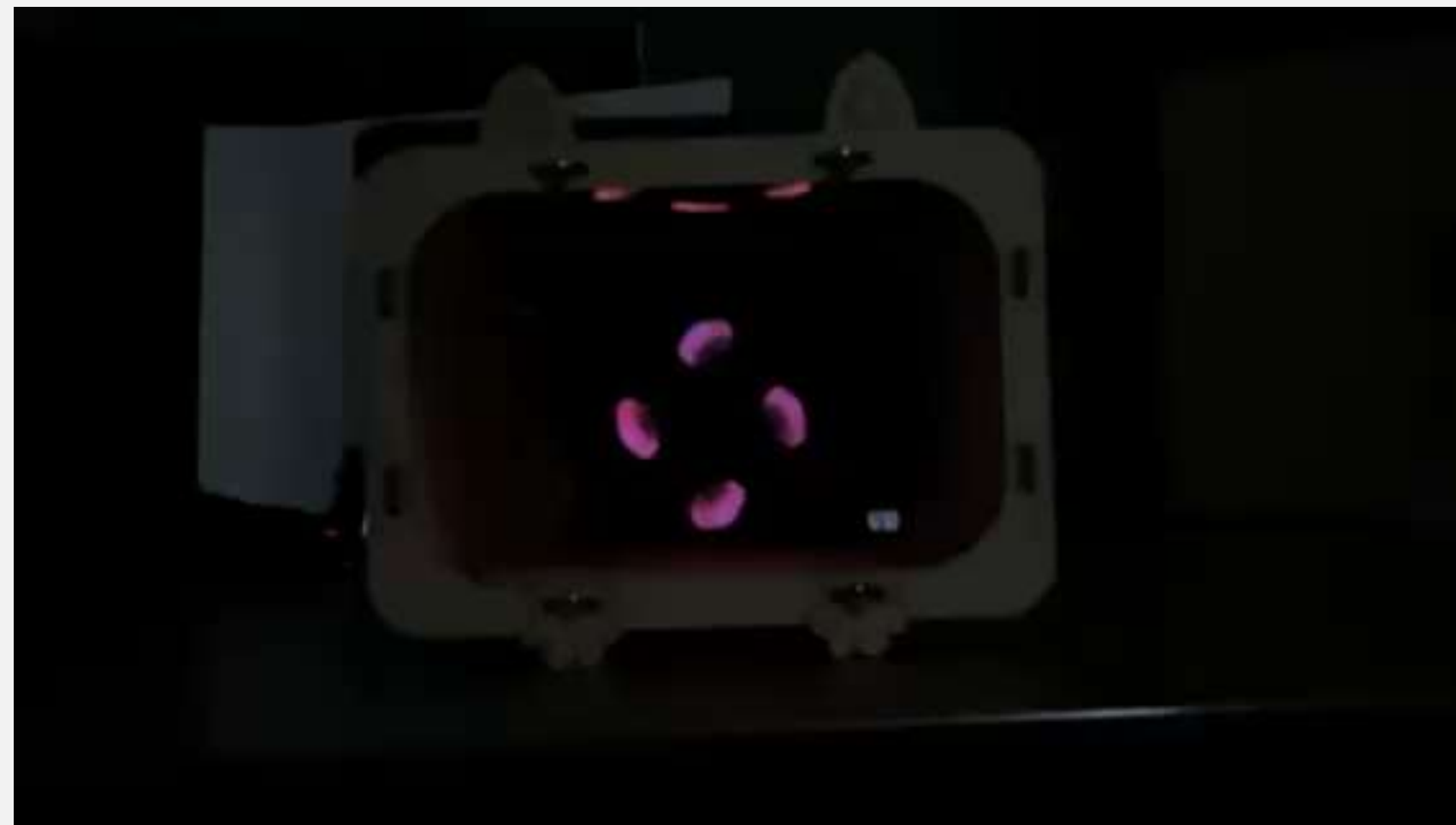

3D投影效果 (4K)



光的反射探究實驗

學習目標

- 瞭解某些材質會重定向光線。
- 描述鏡像的工作原理。
- 研究如何使用反射材料重定向光束。

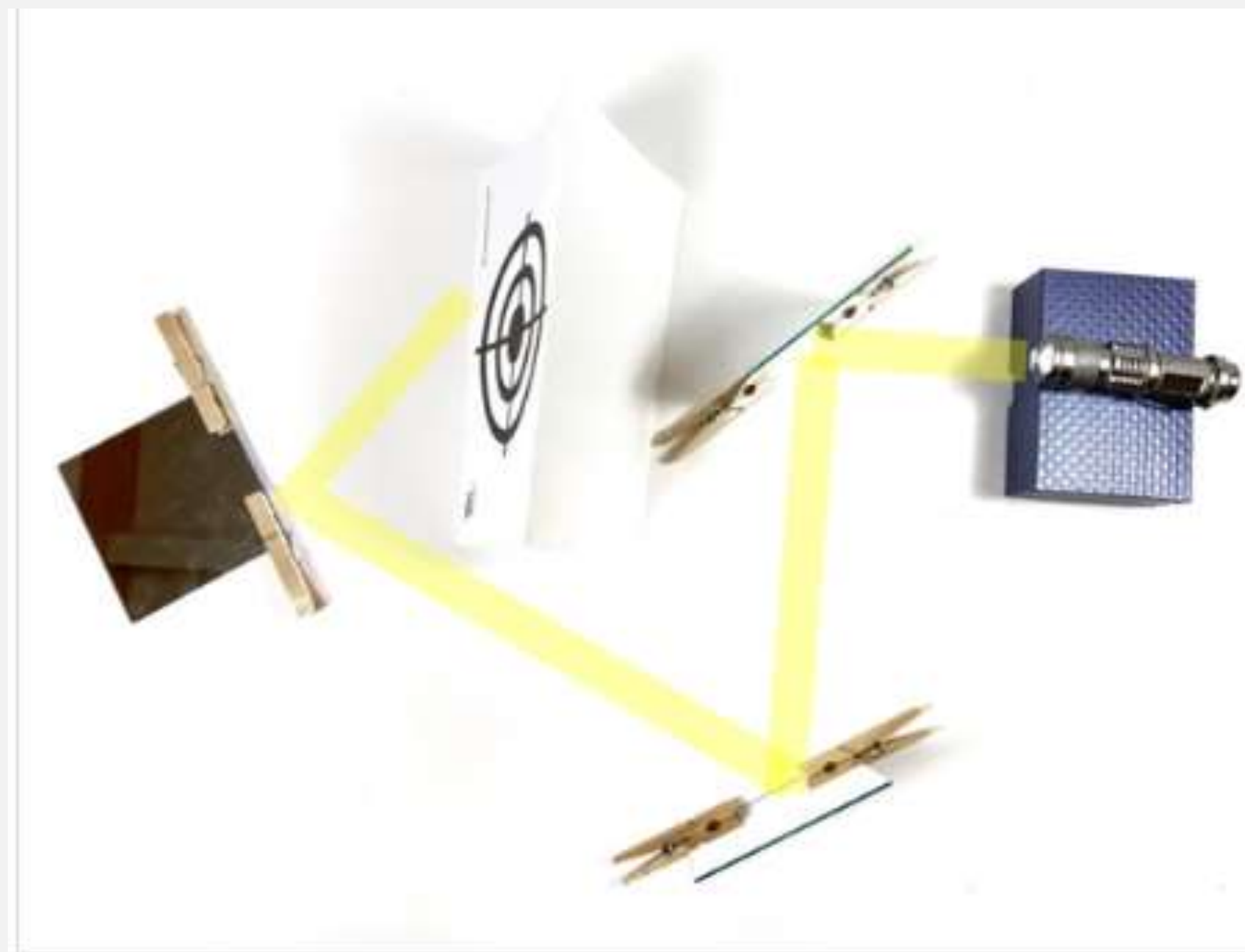

光的反射探究實驗

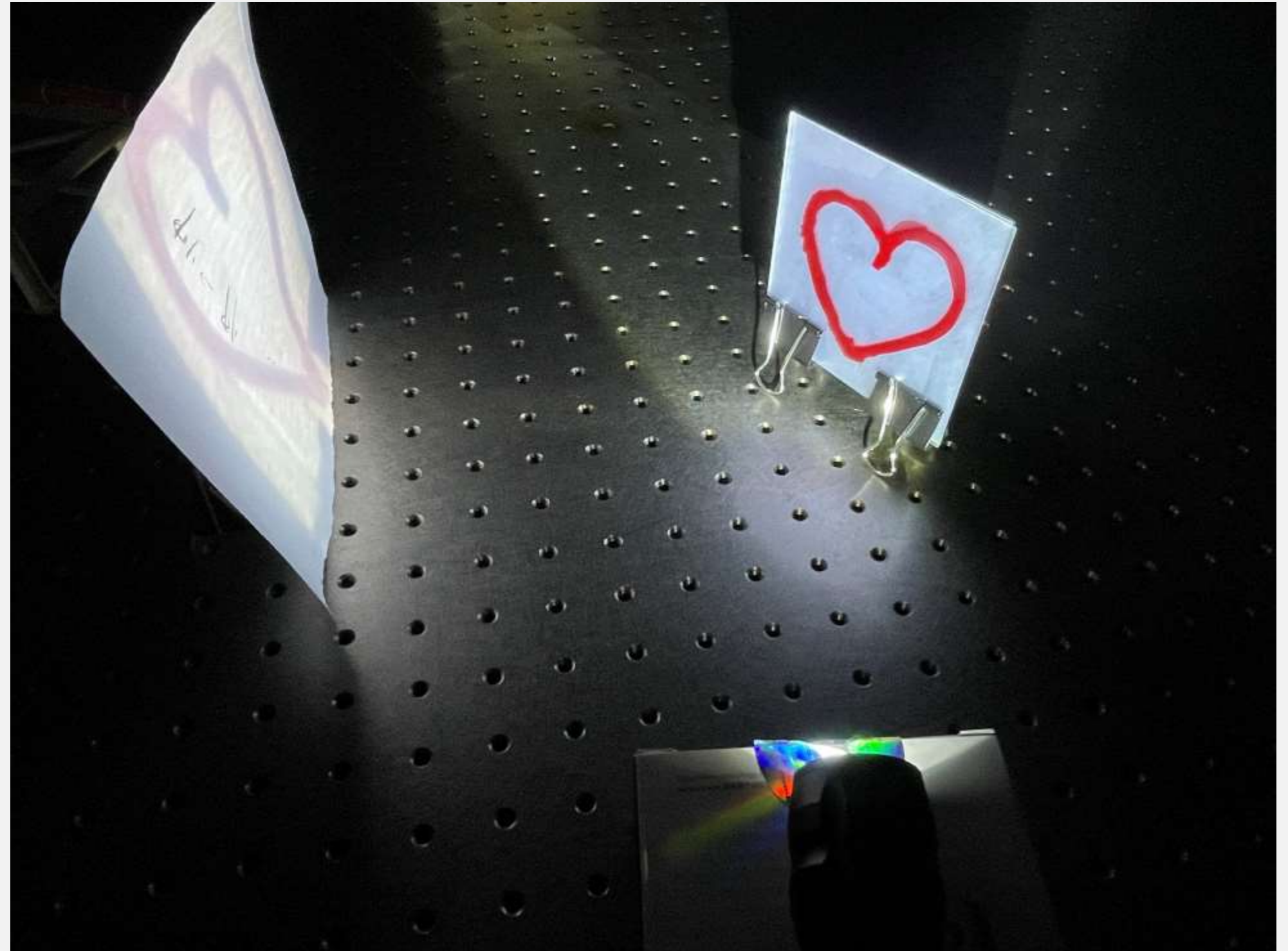
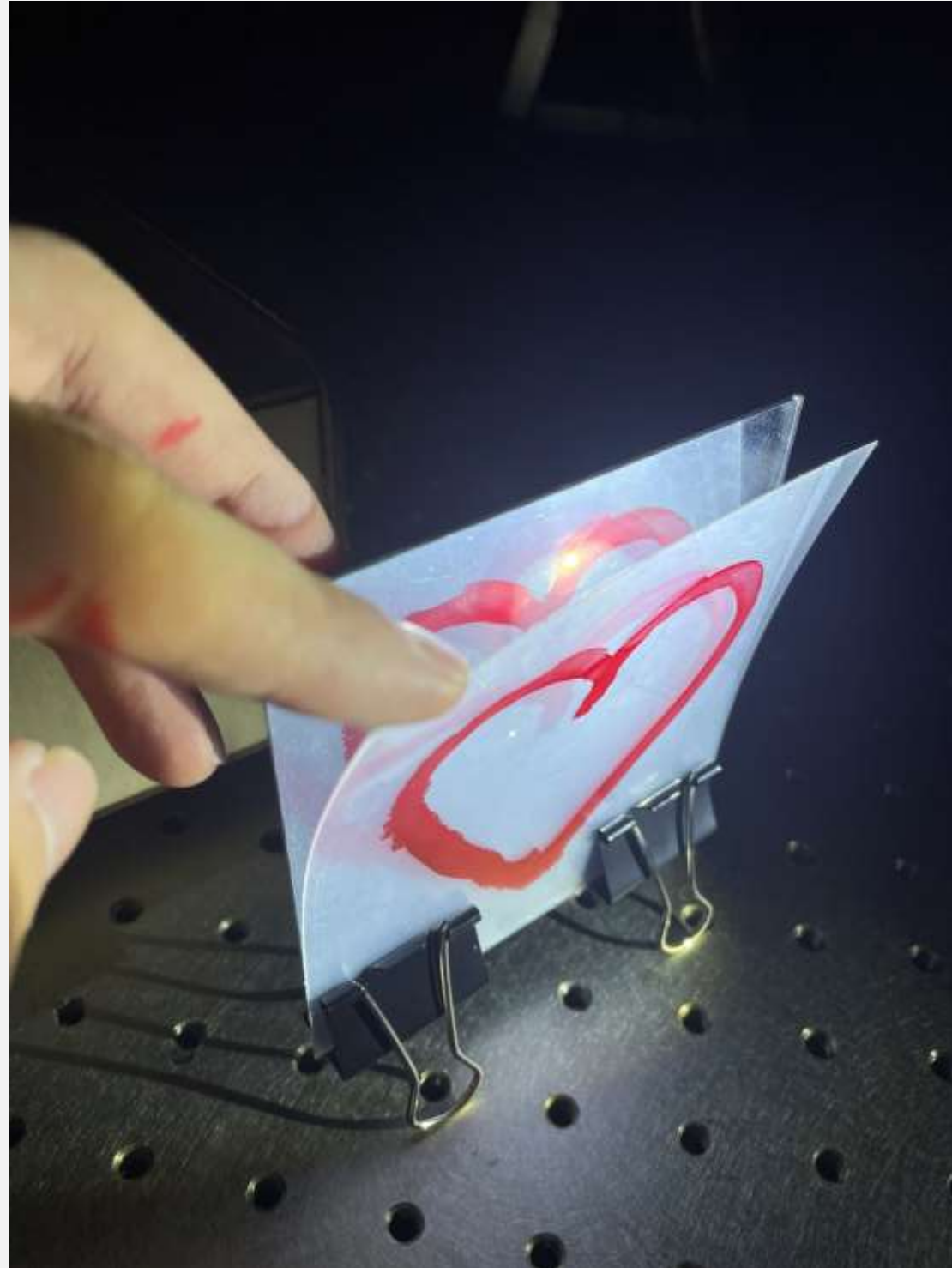

光的反射探究實驗

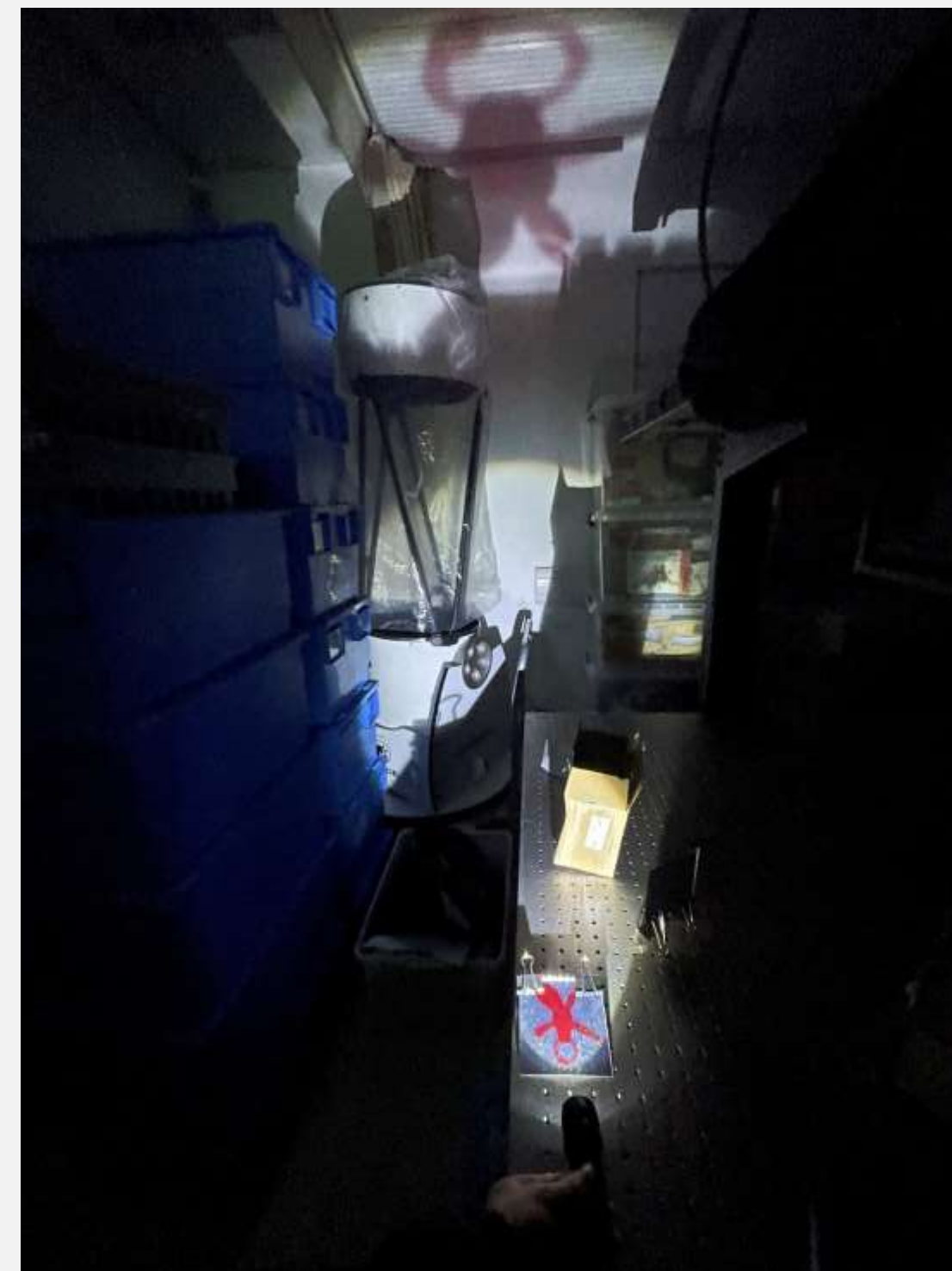
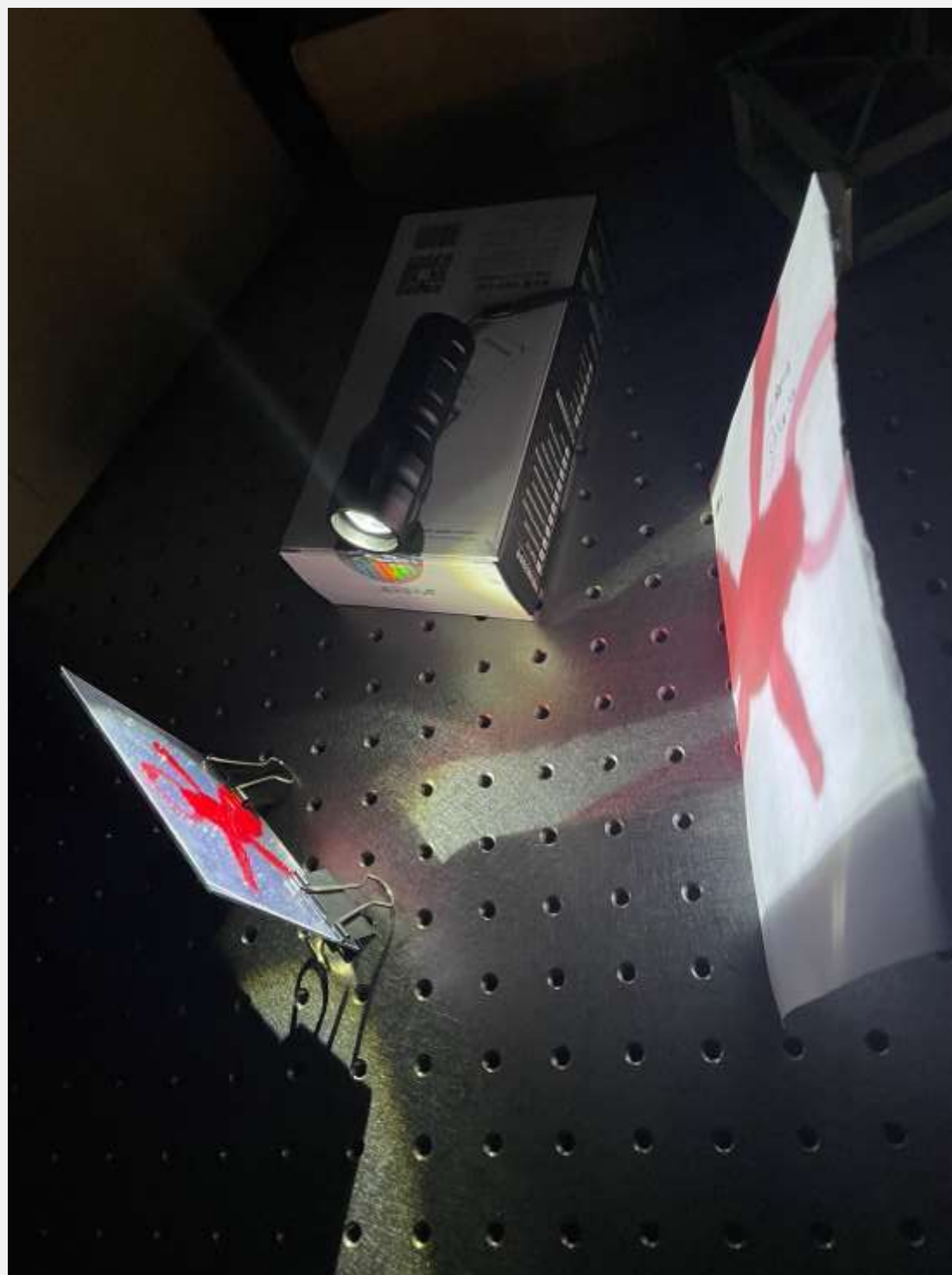

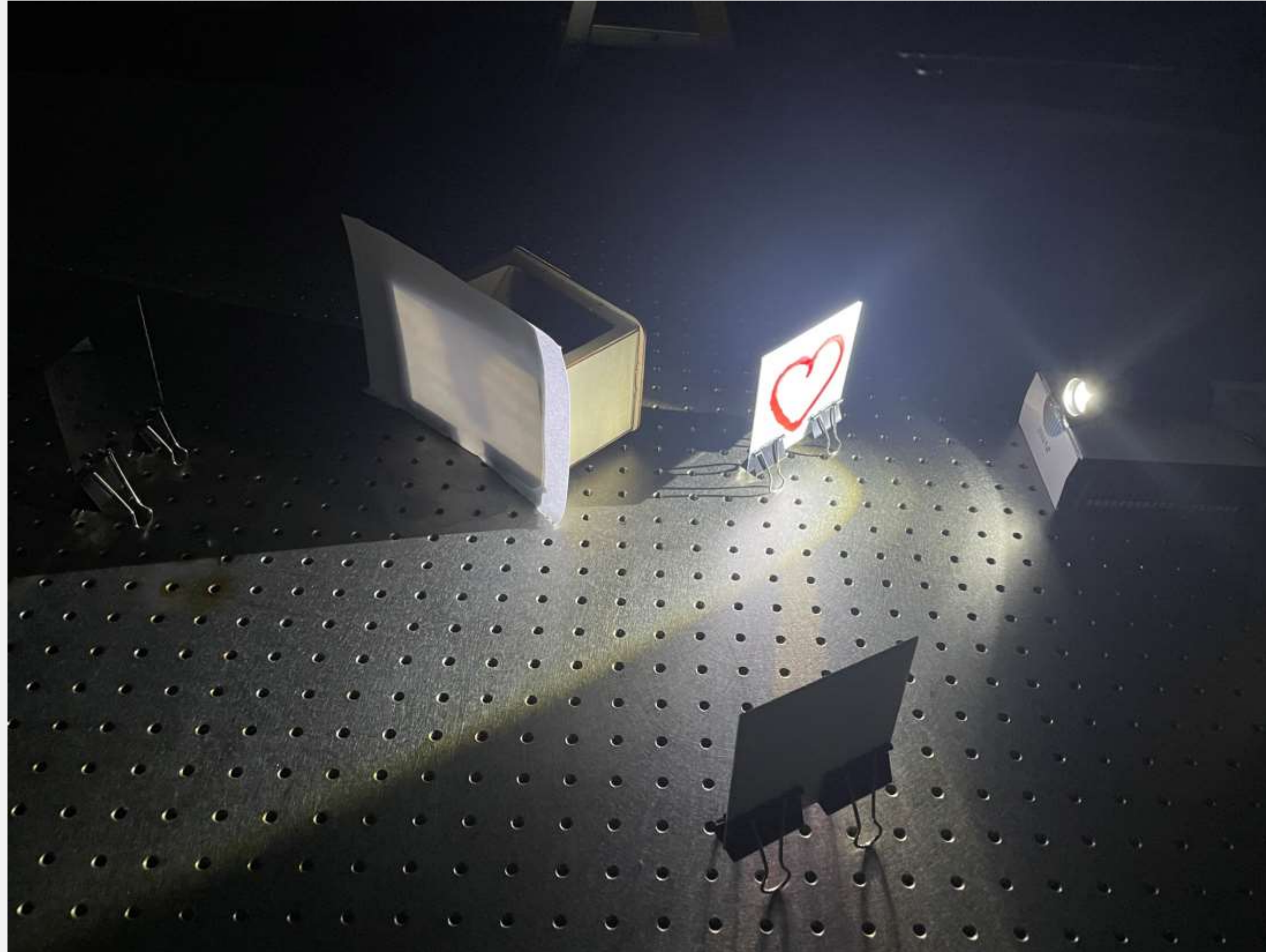

AI 生圖

www.canva.com

The image shows the Canva website interface. On the left is a sidebar with navigation options: 首页 (Home), 项目 (Projects), 模板 (Templates), 品牌 (Brands), 应用 (Apps), and 画梦工坊 (Dream Studio). The main content area features a search bar at the top with the text '搜索模板或你的设计'. Below the search bar is a large purple banner with the text '探索视频' (Explore Videos) and a button '查看新内容' (View New Content). A red circle highlights the '白板' (Whiteboard) icon in the central navigation bar, which also includes icons for '文档' (Documents), '演示文稿' (Presentations), '社交媒体' (Social Media), '教育培训' (Education), '视频' (Video), '平面物料' (Print Materials), '网站' (Websites), '自定义大小' (Custom Sizes), and '上传' (Upload). Below the navigation bar are four buttons: '生成一张图片' (Generate an image), '帮我写一份初稿' (Help me write a draft), '调整任意设计的尺寸' (Adjust the size of any design), and '移除背景' (Remove background). At the bottom, there is a section titled '最近的设计' (Recent designs) showing a grid of design thumbnails.

文件 调整尺寸 编辑 重点词汇 4/5000 通用场景 roadster 升级到 Canva可画高级版

品牌 上传 画笔 项目 应用 AI生图 Sketch To ...

sketch

Sketch To Life Photo To Sketch Text to Speech Sketchify

AI Text to Speech Text-to-S... AI Interior Styler Voiceover Labs

Reimagine Animated Subtitles Voiceover AI Gen Voice

Ai Shop Sync AI Voice Audioz

AiVOOV - Voiceover

备注 计时器 页数 1/1 84%

應用

The screenshot shows the Canva web interface. At the top, there is a navigation bar with icons for home, files, dimensions, editing, undo, redo, and a search bar. The search bar contains the text "重点词汇 4/5000 通用场景 roadster" and a button to "升级到 Canva可画高级版". Below the navigation bar is a sidebar with various AI tools. A red circle highlights the search bar in the sidebar, which contains the text "sketch". To the right of the sidebar, the text "輸入Sketch" is written in large red characters. The main workspace is a grid of dots. At the bottom, there is a footer with icons for notes, timer, page number (1/1), zoom (84%), and other utility icons.

文件 调整尺寸 编辑 重点词汇 4/5000 通用场景 roadster 升级到 Canva可画高级版

品牌 搜索 sketch

Sketch To Life Photo To Sketch Text to Speech Sketchify

AI Text to Speech Text-to-Speech AI Interior Styler Voiceover Labs

Reimagine Animated Subtitles Voiceover AI Gen Voice

AiVOOV - Voiceover Shop Sync AI Voice Voiceover Studio

备注 计时器 页数 1/1 84%



文件 调整尺寸 编辑 未命名的设计- 白板 升级到 Canva可画高级版 C + 分享

品牌
上传
画笔
项目
应用
AI生图
Sketch To ...

Sketch To Life
Your sketch
Clear

Describe your sketch
Modern home, tree, road...

繪圖區

关键词

备注 计时器 页数 1/1 100%

Step 5

The screenshot shows the Canva AI image generation workflow. On the left, a purple line-art sketch of a UFO is displayed in the 'Sketch To Life' panel. Below the sketch is a 'Clear' button and a text input field containing 'UFO, grey color'. A large purple 'Generate' button is at the bottom of this panel. On the right, the resulting 3D rendered image of a blue and grey UFO is shown in a separate window with a dotted grid background. The top navigation bar includes icons for '文件' (Files), '调整尺寸' (Adjust Size), '编辑' (Edit), and '重点词汇 4/5000 通用场景 roadster' (Keywords 4/5000 General Scenario roadster). The bottom bar contains '备注' (Notes) and '计时器' (Timer) icons.



AI生图-3D投影效果

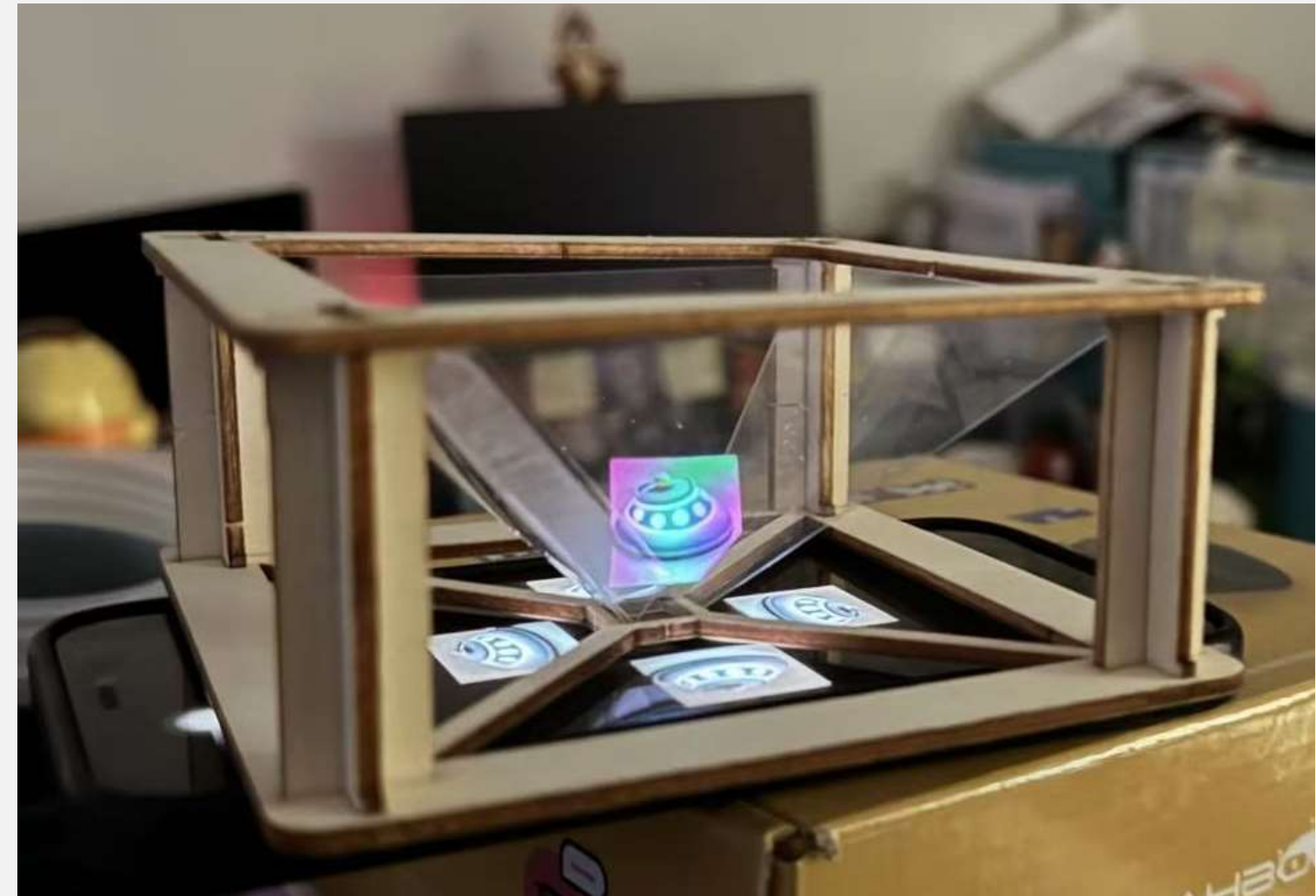

AI生图-3D投影效果

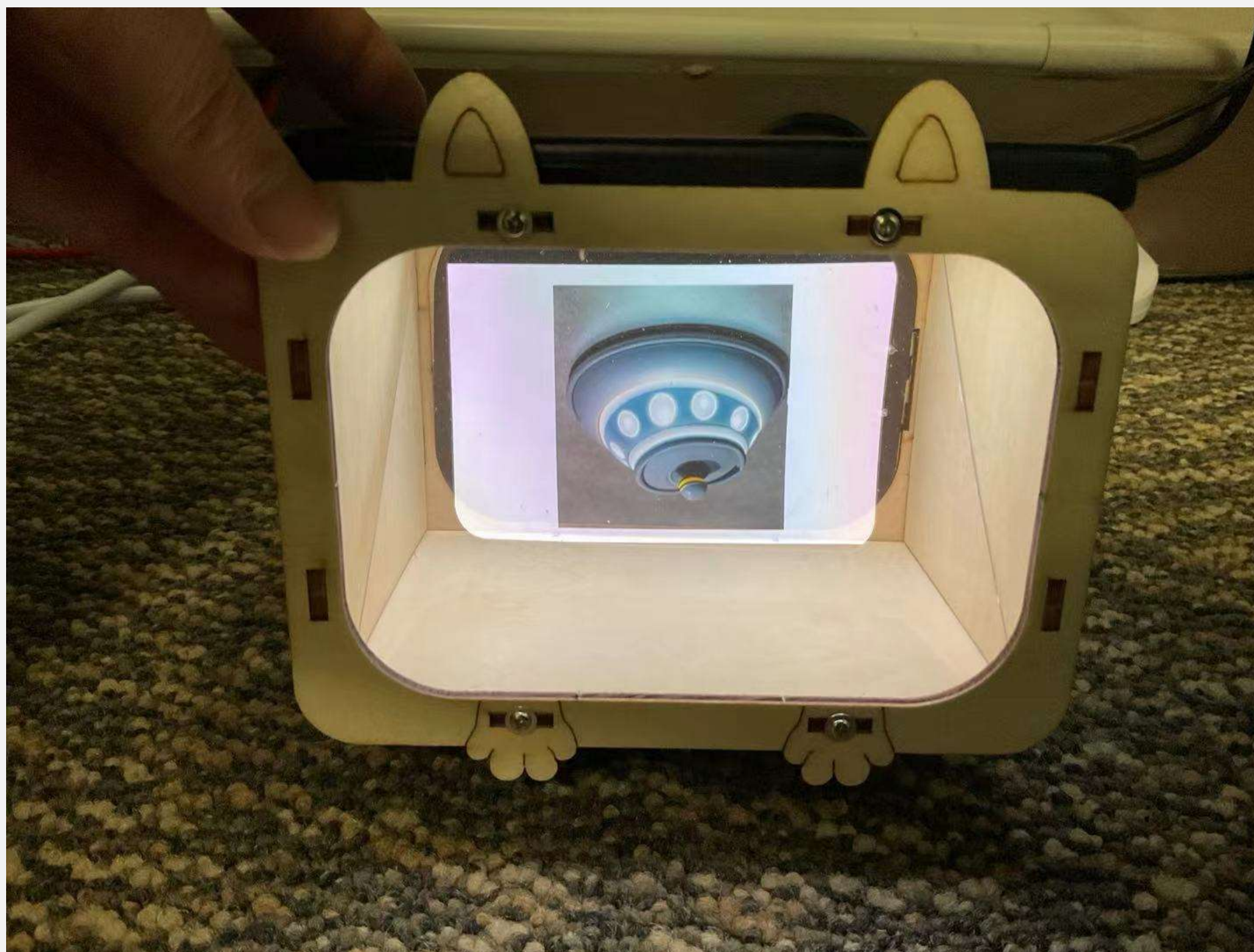



AI圖生成-Canva (APP&電腦) [首页 - Canva可画](#)

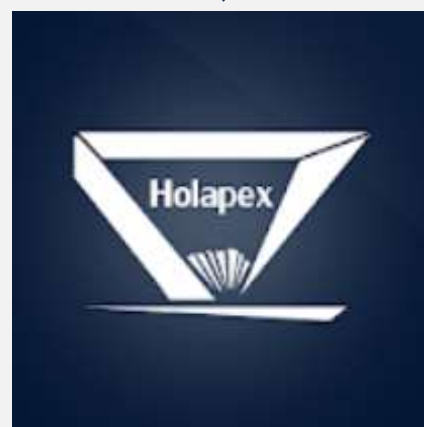

3D投影生成圖片軟體 -Holopex Hologram Video Maker (APP)



圖片生成視頻軟體-即夢 (APP&電腦) [即梦AI - 一站式AI创作平台](#)



Holapex Hologram 操作流程

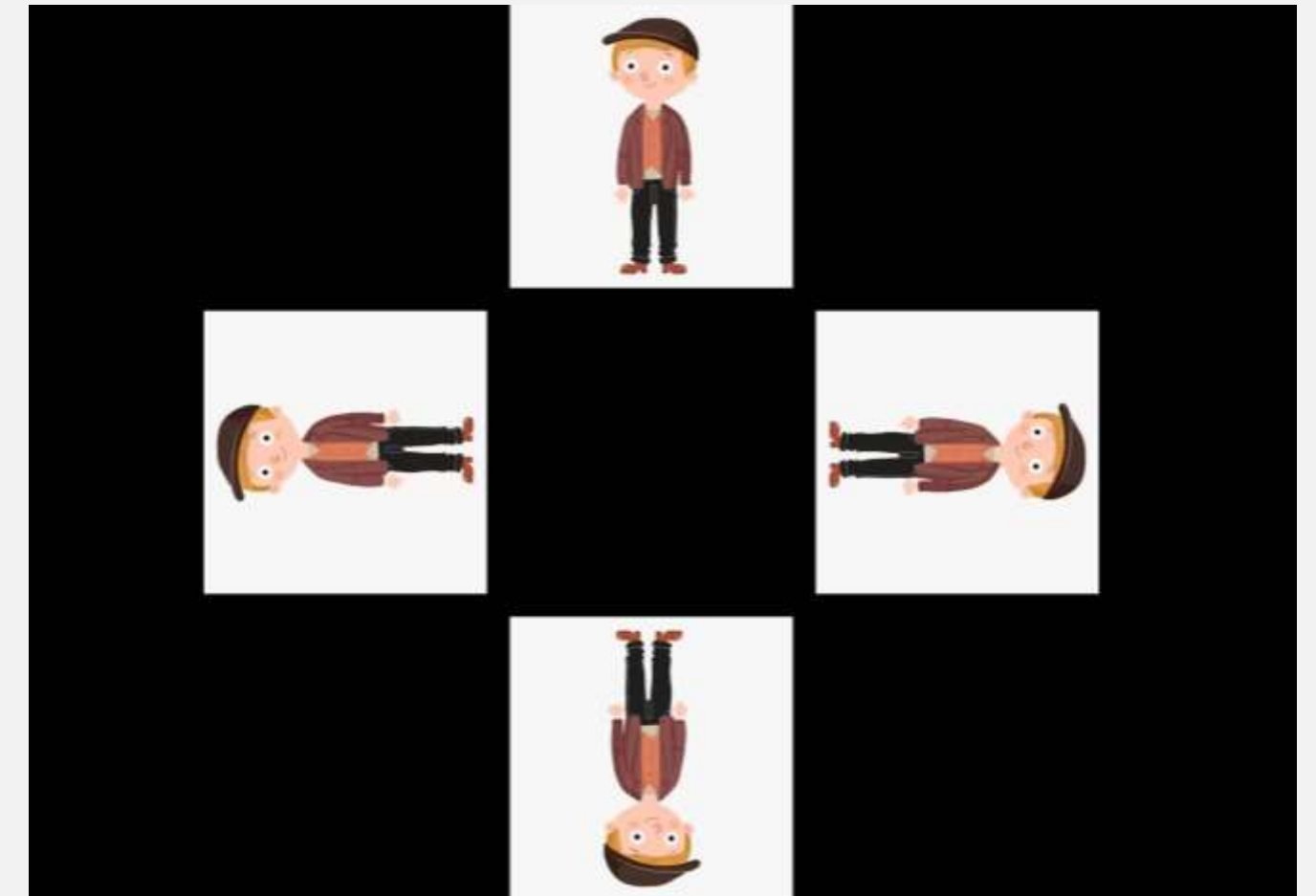
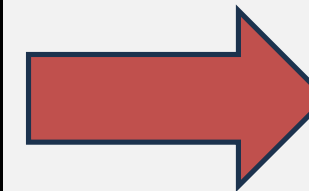
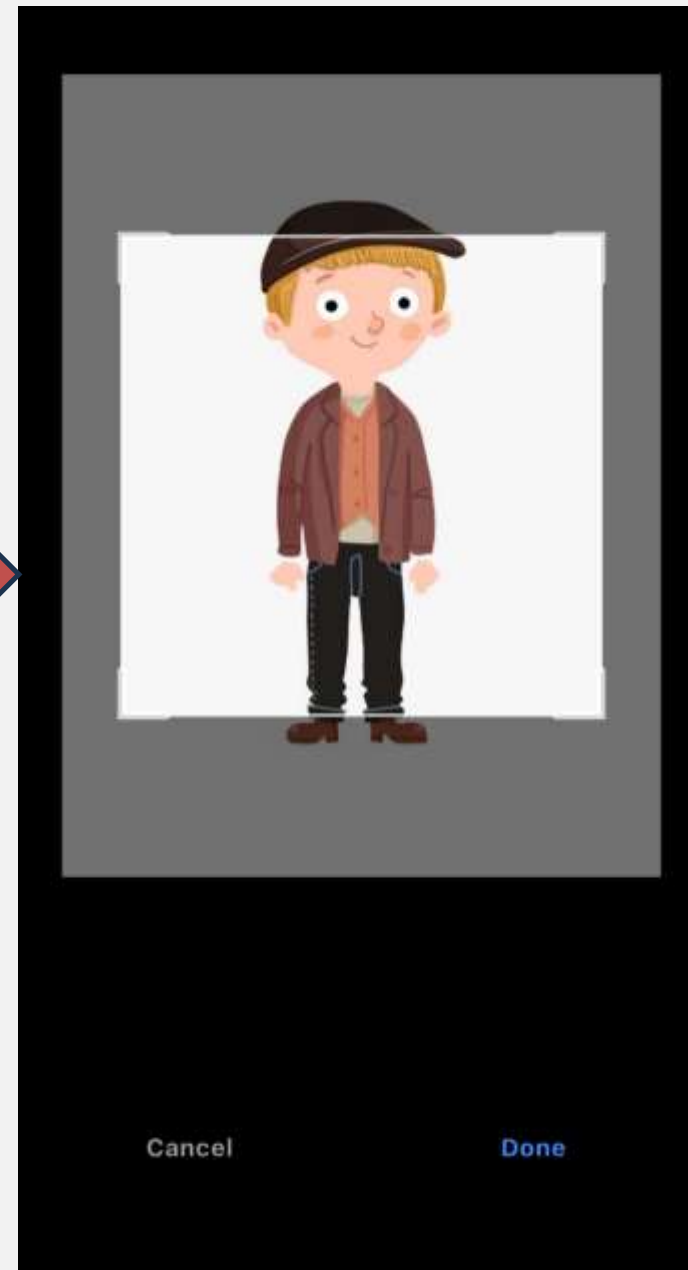
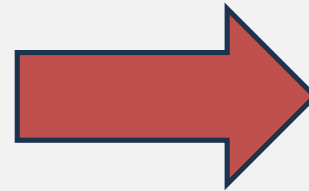
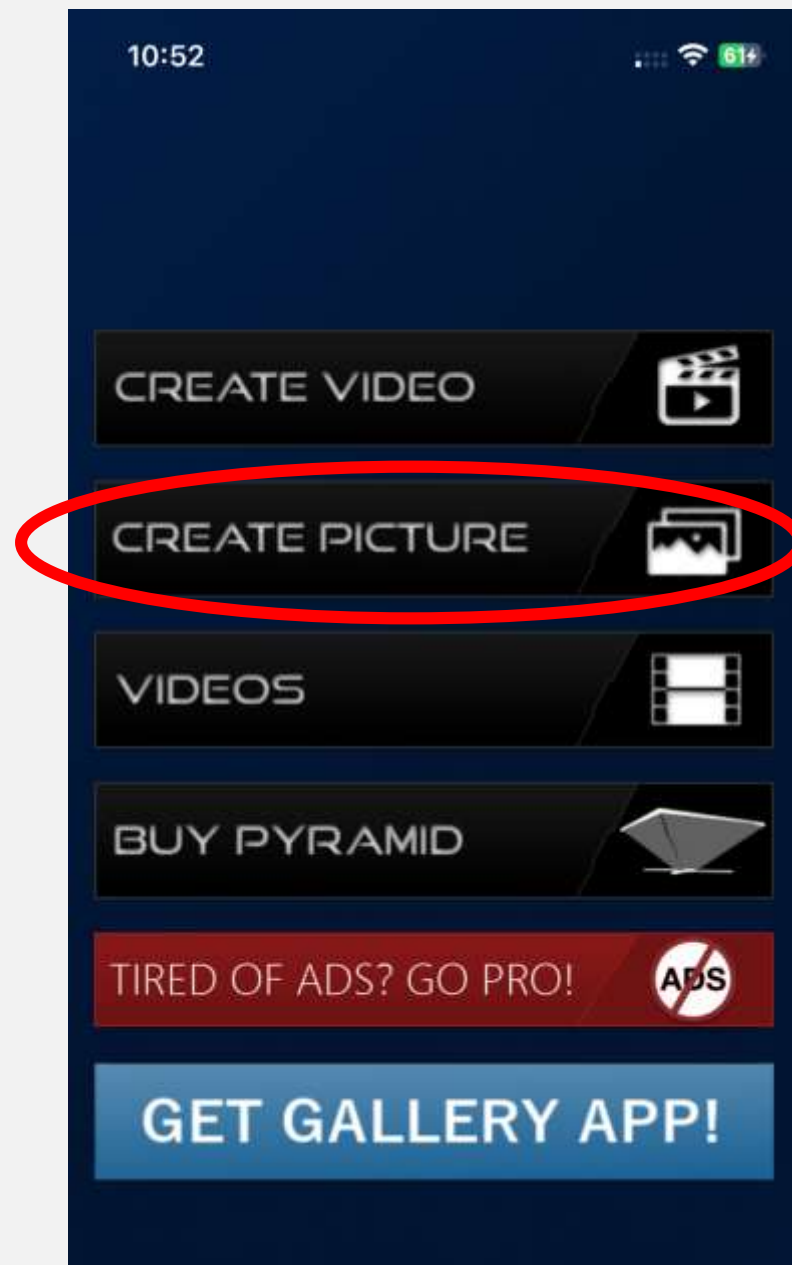

即夢-操作流程

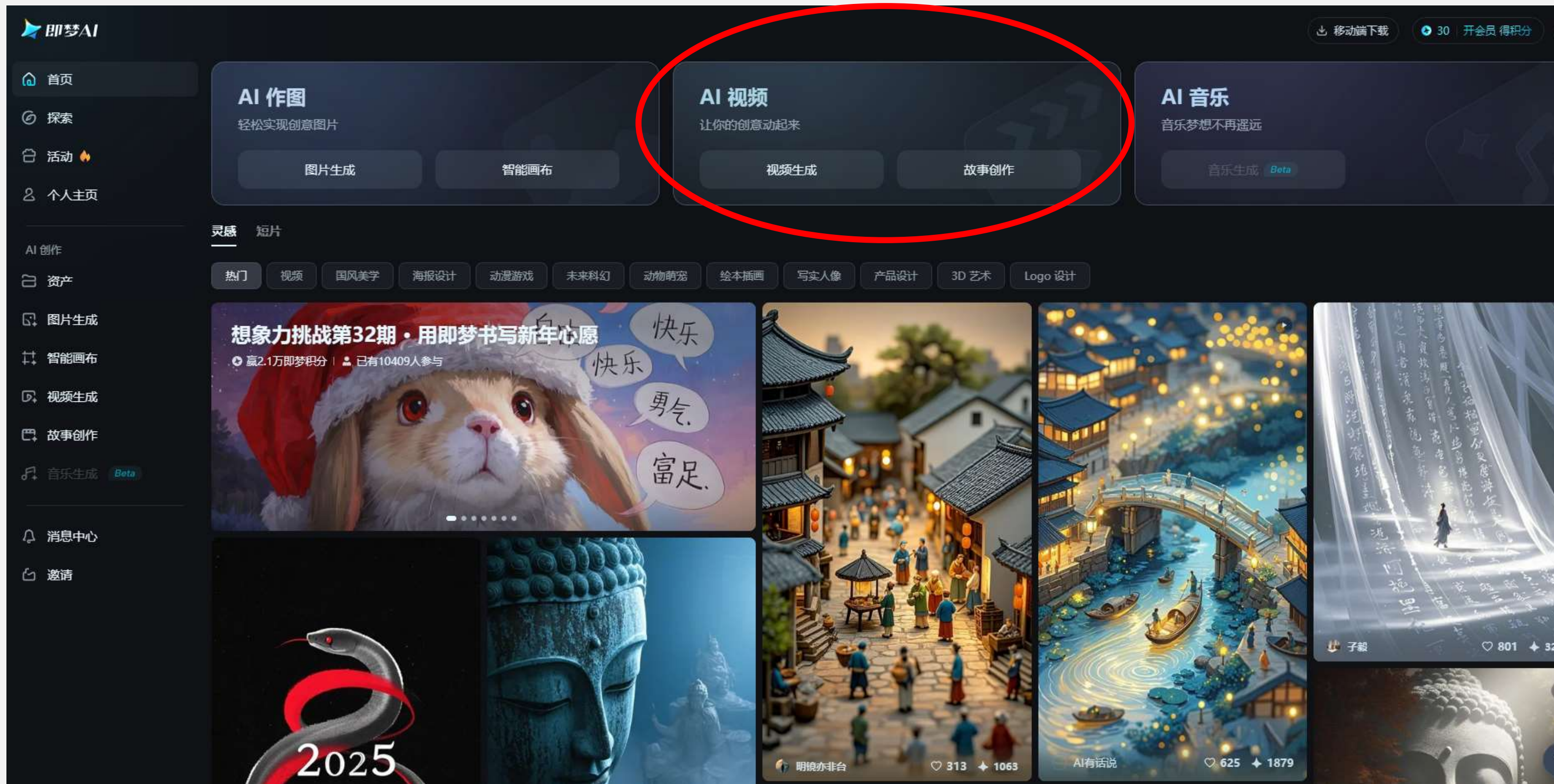

即夢-操作流程

上傳圖片

關鍵字

推薦視頻1.2

可生成AI背景音樂

即夢-生成視頻效果

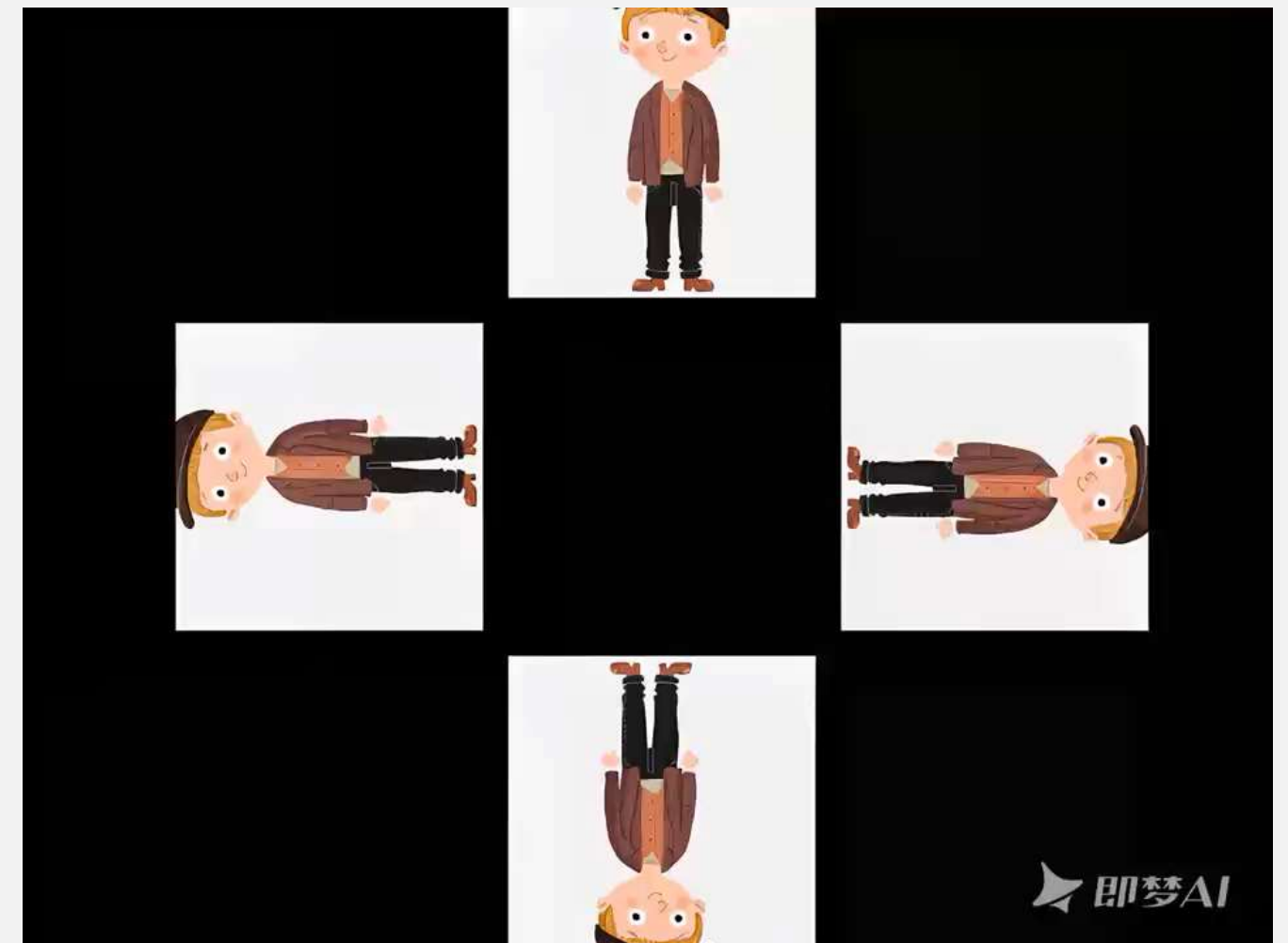
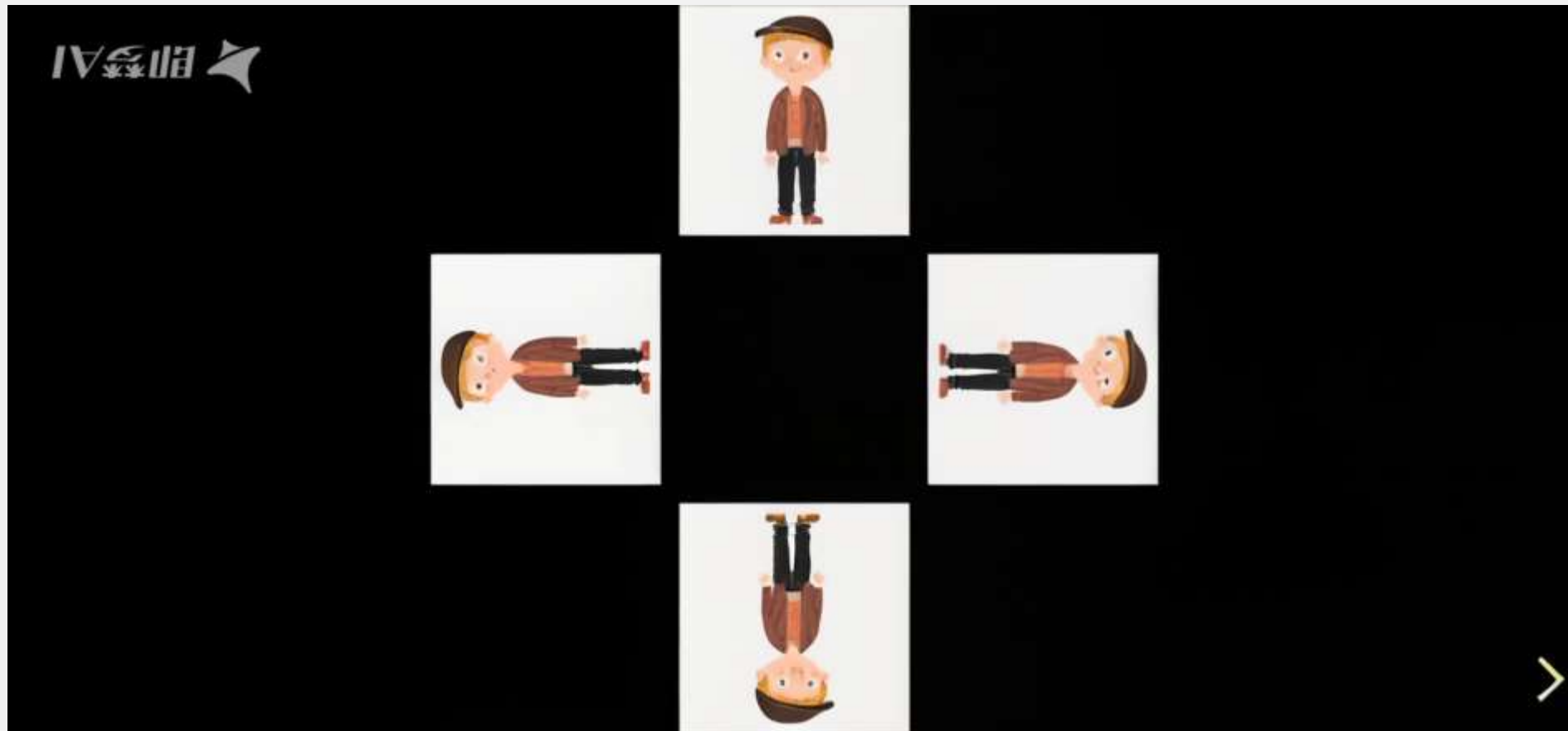

參考關鍵字:

上下左右四張圖片中男孩同步跳舞，男孩分別固定在圖片中跳舞，圖片保持不動

3D投影效果

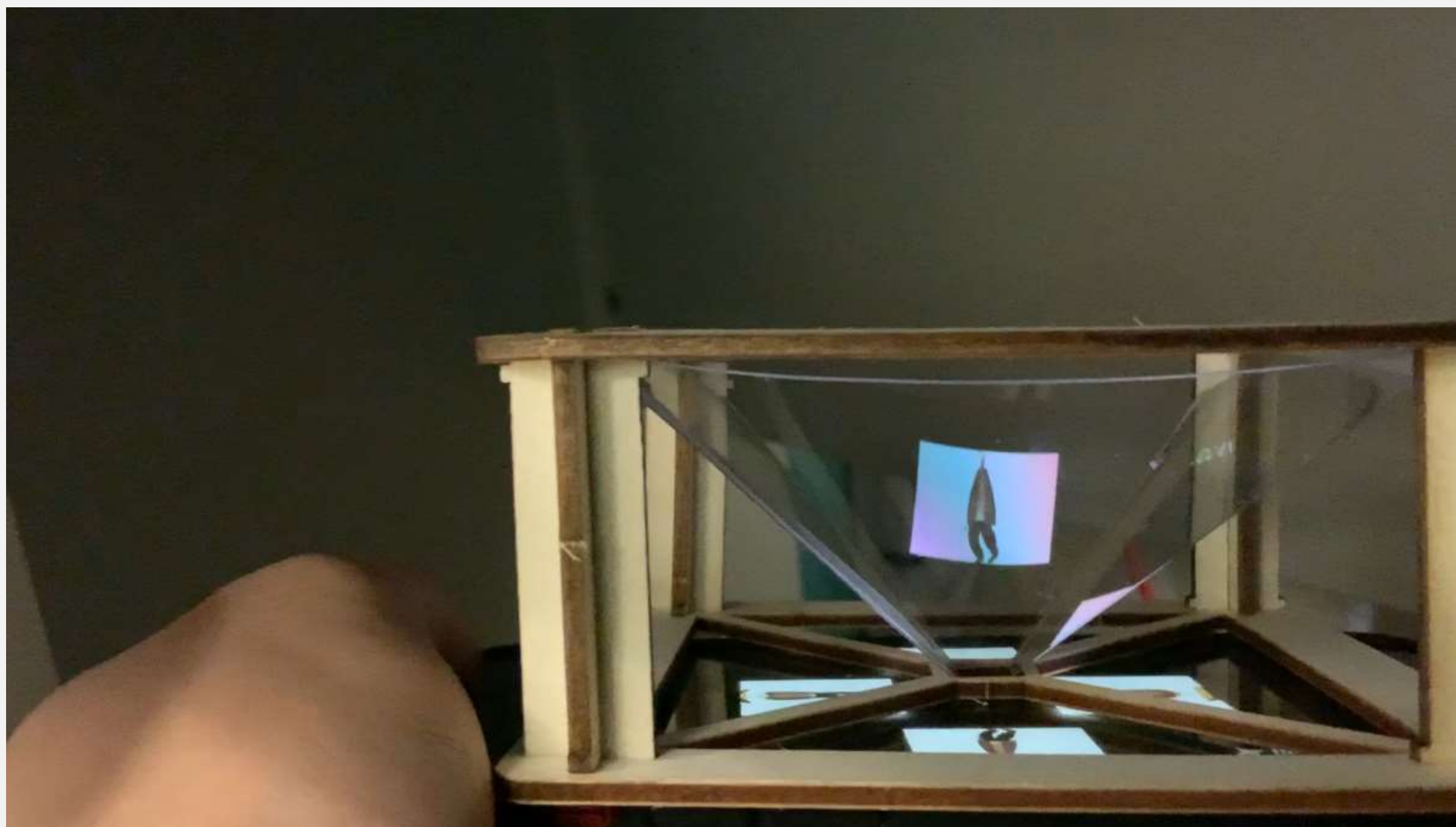

Option Choice-GoEnhance

The screenshot displays the GoEnhance AI website interface. At the top, there is a navigation bar with the GoEnhance logo, a dropdown menu for 'APP New', and links for 'Home', 'Pricing', 'Affiliate', and 'API'. A user profile icon and a '21' notification badge are visible on the right. The main content area is titled 'Main Apps' and features four large, dark-themed cards with rounded corners. Each card has a title, a brief description, and a 'Generate' button. The cards are: 1. 'Video to Video' with the description 'Turn your video into different anime style videos' and an image of a woman. 2. 'Video Face Swap' with the description 'Change any face in videos with our AI video face swapper' and an image of a face being swapped onto Iron Man. 3. 'Text to Image' with the description 'Convert text to image using powerful Image Generation' and an image of a futuristic helmet. 4. 'AI Videos' with the description 'Turn text or image to video, bring your vision to life!' and an image of a panda reading a book. Below the 'Main Apps' section, there are two columns of smaller cards. The left column is titled 'Video Apps' and contains 'Go Act' (description: 'Video brings characters to life - everyone's an actor with Go Act') and 'Creative Style Transfer' (description: 'Transfer your video into a creative style.'). The right column is titled 'Image Apps' and contains 'Image Face Swap' (description: 'Seamlessly swap faces in your photos.') and 'Image Enhancer' (description: 'Enhance and upscale your image to extreme detail.'). Each of these smaller cards also has a right-pointing arrow.

[GoEnhance AI - Video to video, Image enhancer and upscaler](https://app.goenhance.ai)

GoEnhance

生成視頻效果

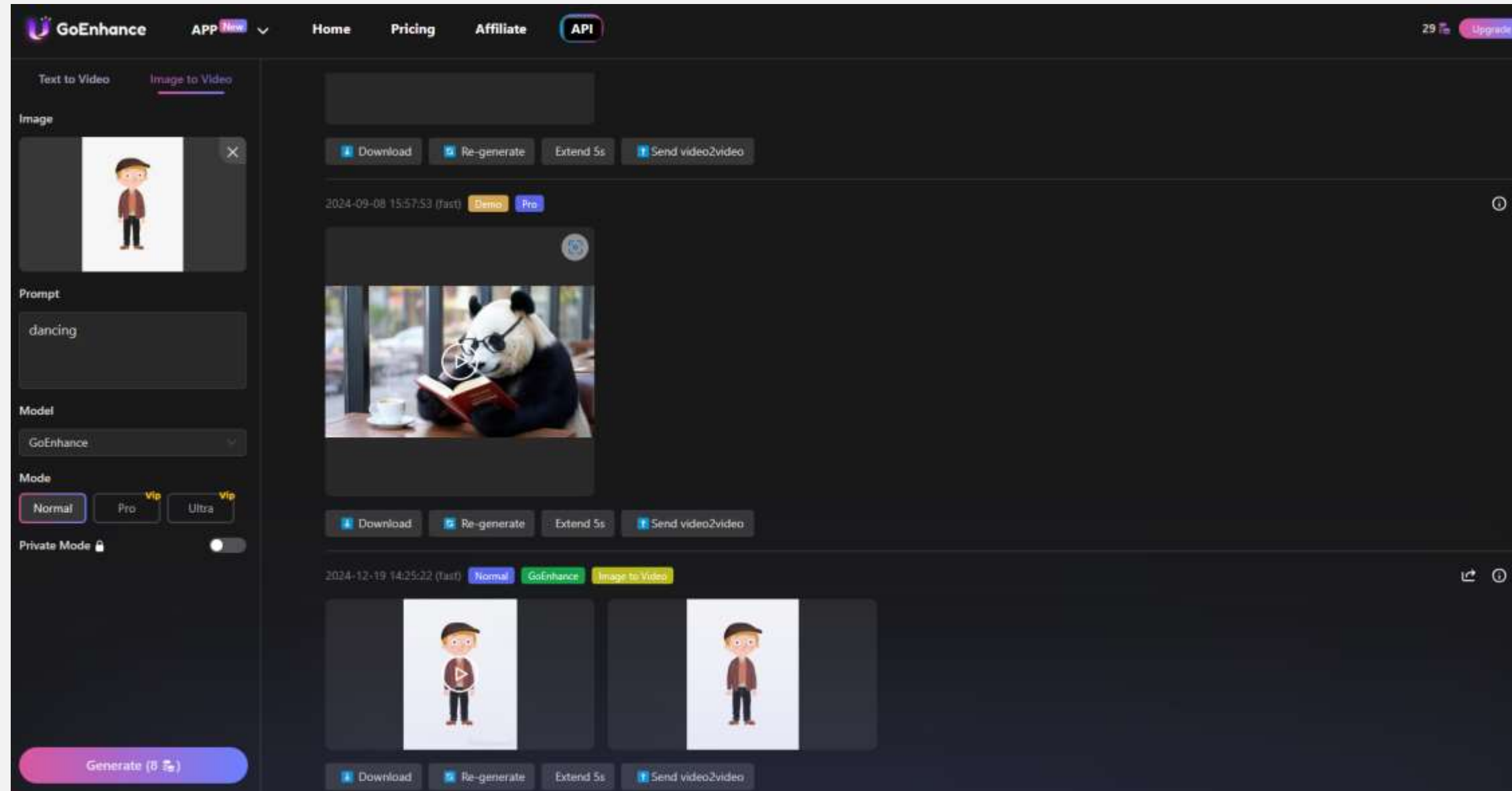

[GoEnhance AI - Video to video, Image enhancer and upscaler](#)

支架示例

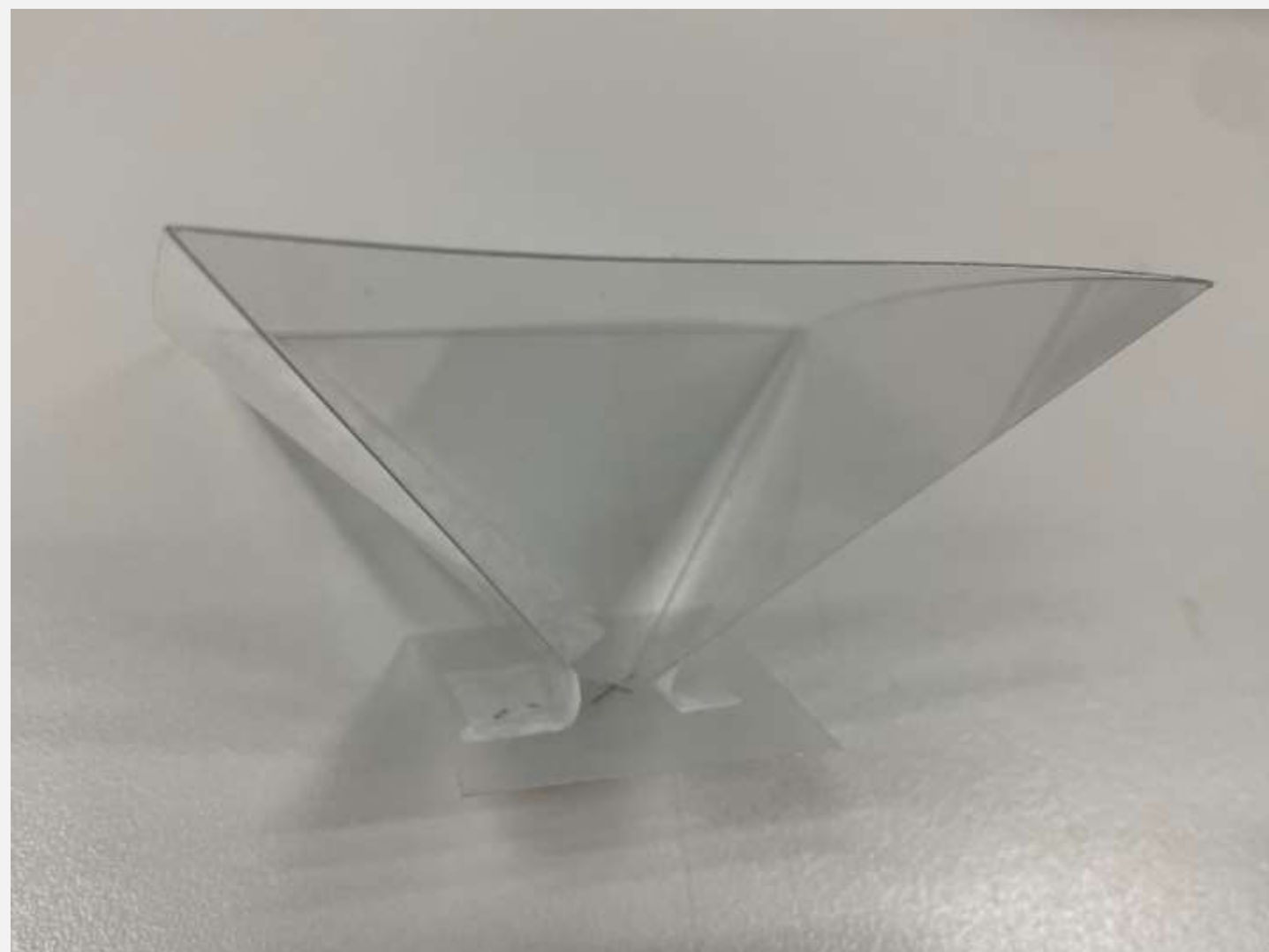

支架示例

